

ROHS

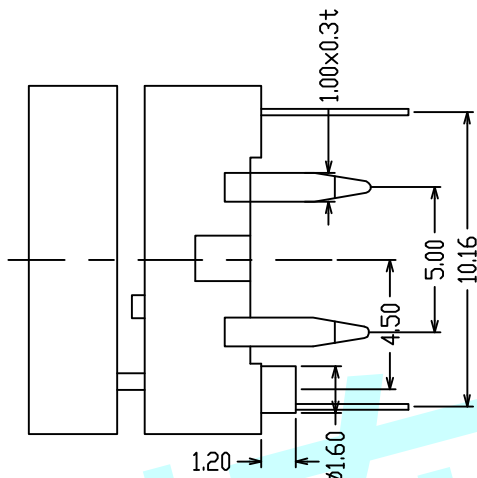

NOTES:

A. Electrical characteristics

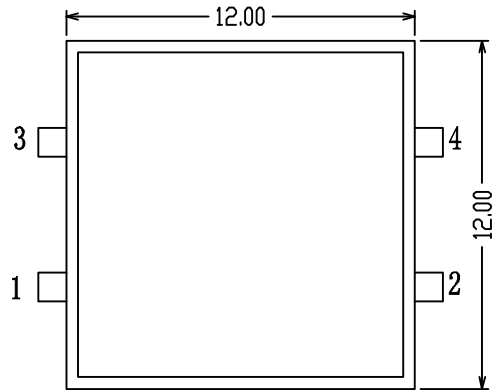

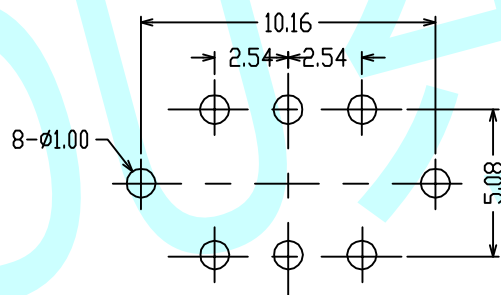
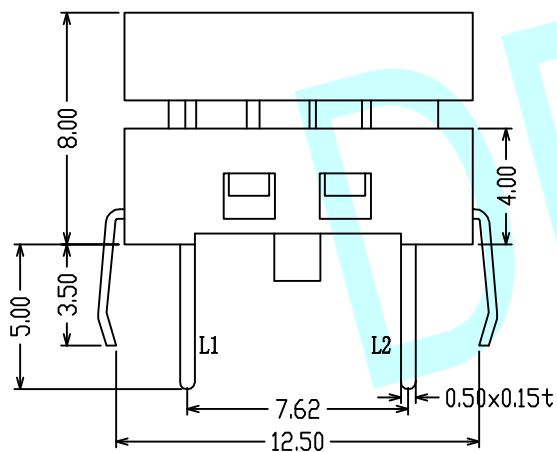
1. Rating: 50mA 12V DC
2. Contact resistance: 100mΩ max
3. Insulation resistance: 100MΩ min
4. Dielectric strength: AC 250V (50~60Hz) for 1 minute
5. Usage temperature: -25°C~+80°C
6. Service life: 100,000 cycles

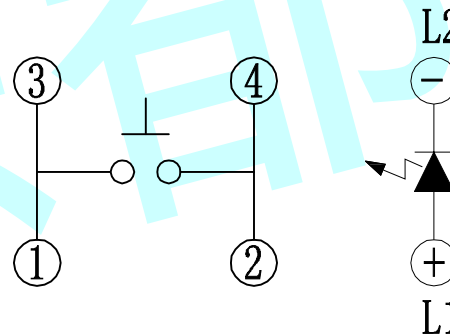

PCB Layout (Pattern Side)



Circuit Diagram

LED Colour (LED颜色)		Whiler (白色)	Red (红色)	Blue (蓝色)	Green (绿色)
APPROVALS		DATE	http://www.dongdudz.com		
DRAW:	ZRD	2017-12-6	TOLERANCE:	ANGLE:	
CHECKED:	***	****	30°	±0.30	±2°
APPOVALS:	***	****	10°30'	±0.20	
			5°10'	±0.15	
			≤5	±0.10	
				 <b>东都电子</b> DONGDU ELECTRONICS	
MODEL:		LED Tact Switch			
PART NO:		DDU-1543			
UNIT :mm		SCALE: 1:1			
REV:		A		PAGE: 1/1	