

ROHS

CCW ← PUSH → CW

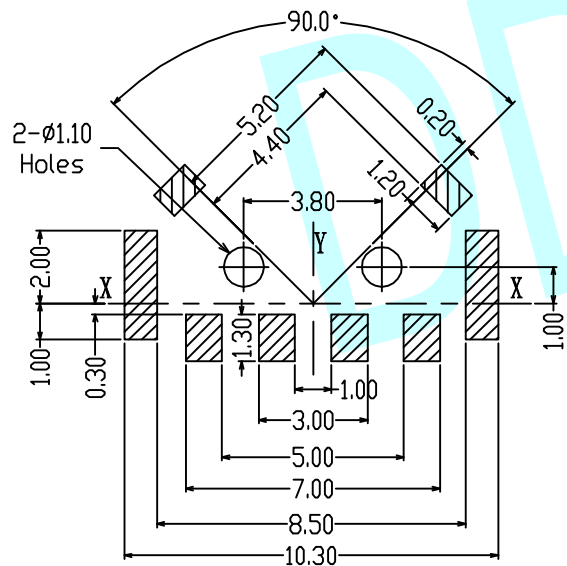

PCB Mounting
Pattern Dimension

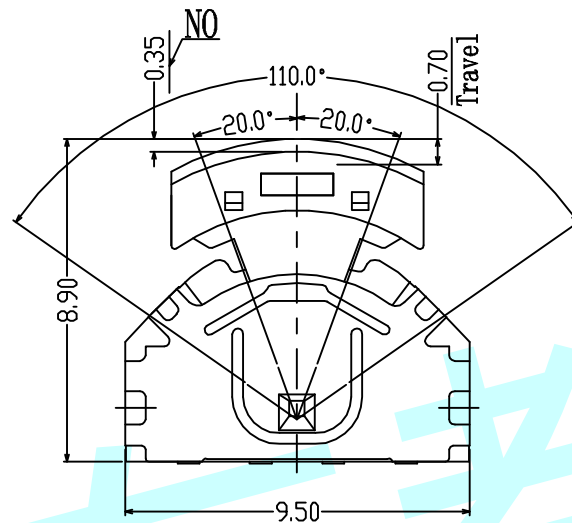
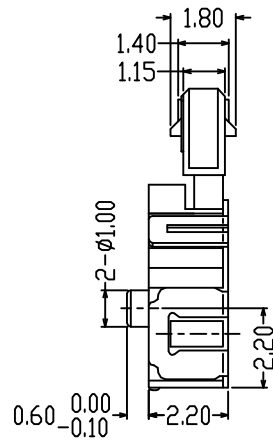
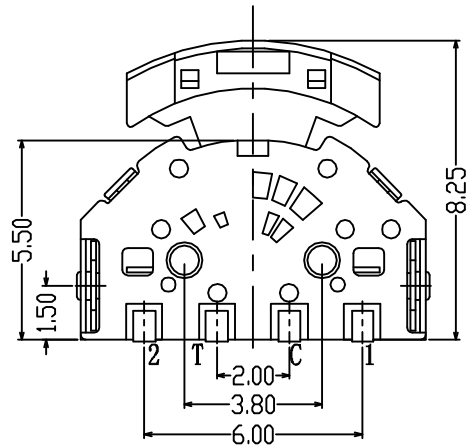
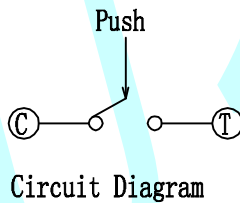

Circuit Diagram

NOTES:



1. Rating: DC 5V 10mA
2. Contact resistance: 100mΩ MAX
3. Insulation resistance: 100MΩ MIN
4. Service life: 30,000 cycles
5. Operating temperature: -25 °C ~ +85 °C
6. Using humidity: ≤85% RH
7. Operating Force :
 - a. Lever Porting : 70±40gf
 - b. Push Portion : 250±40gf
 - c. Travel : -25° ~ +25° Pushportion 0.7±0.10mm

TER	0° (NO)			
	ANG. (20°)	(15°)	(15°)	(20°)
①				
②				
③				

CCW ← → CW

CODE TABLE

APPROVALS		DATE	http://www.dongdudz.com	
DRAW:	ZRD	2017-12-6	TOLERANCE:	ANGLE:
CHECKED:	***	****	30≥ ±0.30	±2°
APPOVALS:	***	****	10~30 ±0.20	
			5~10 ±0.15	
			≤5 ±0.10	

 东都电子 DONGDU ELECTRONICS		MODEL:	ROCKER SWITCH
		PART NO:	DDU-1214
UNIT :mm	SCALE:1:1		
REV:	A		