

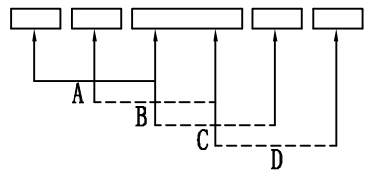

ROHS

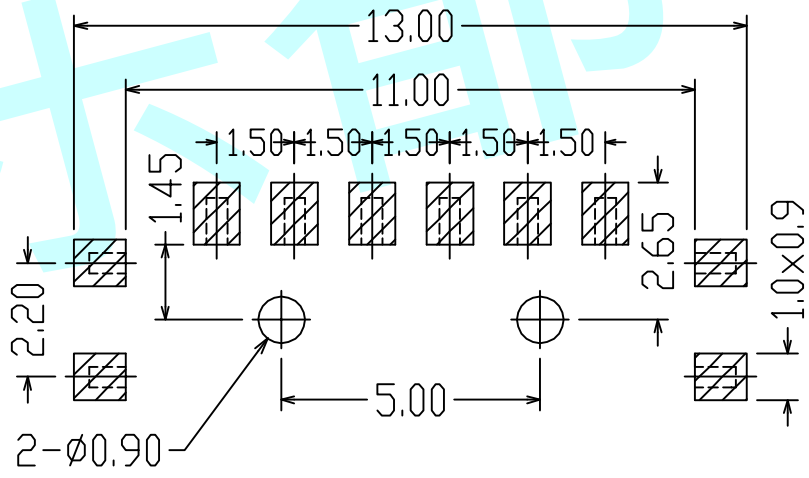
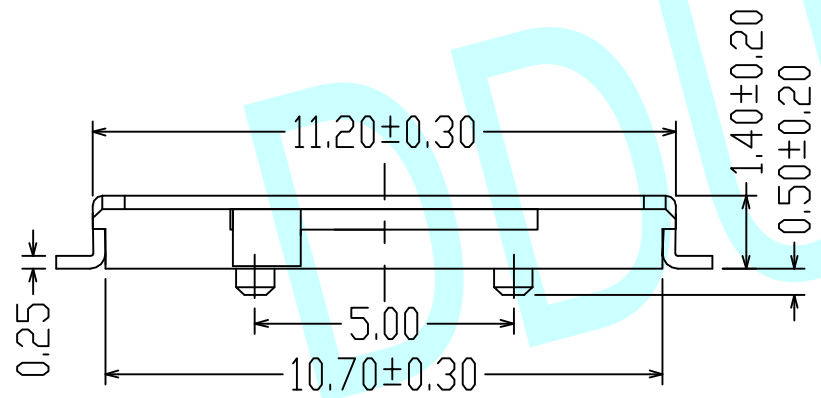
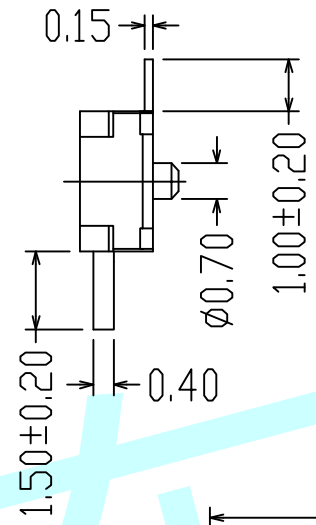
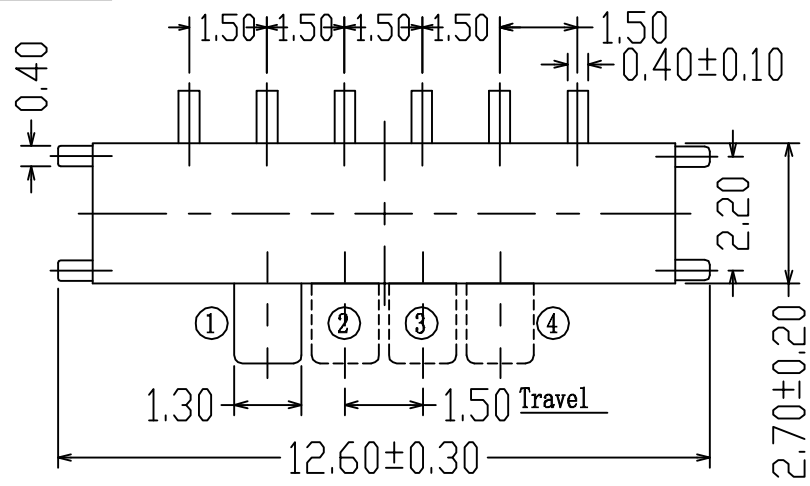

Circuit Diagram

NOTES:
Operating Force: 200 ± 100 gf

PCB Layout (Pattern Side)

APPROVALS		DATE	http://www.dongdudz.com		 东都电子 DONGDU ELECTRONICS
DRAW:	ZRD	2017-12-6	TOLERANCE:	ANGLE:	
CHECKED:	***	***	$30 \geq$	± 0.30	$\pm 2^\circ$
APPOVALS:	***	***	$10 \sim 30$	± 0.20	
			$5 \sim 10$	± 0.15	
			≤ 5	± 0.10	
MODEL:	TOGGLE SWITCHES		UNIT : mm	SCALE: 1:1	
PART NO:	DDU-1423S		REV:	A	PAGE: 1/1