

ROHS

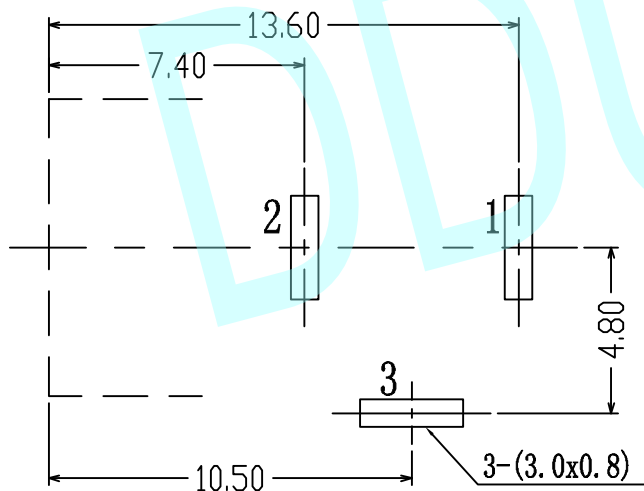

PCB Layout (Copper-Side View)

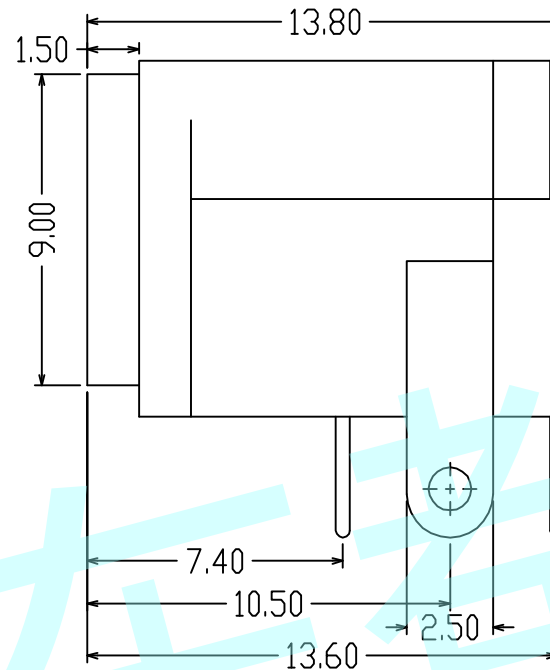
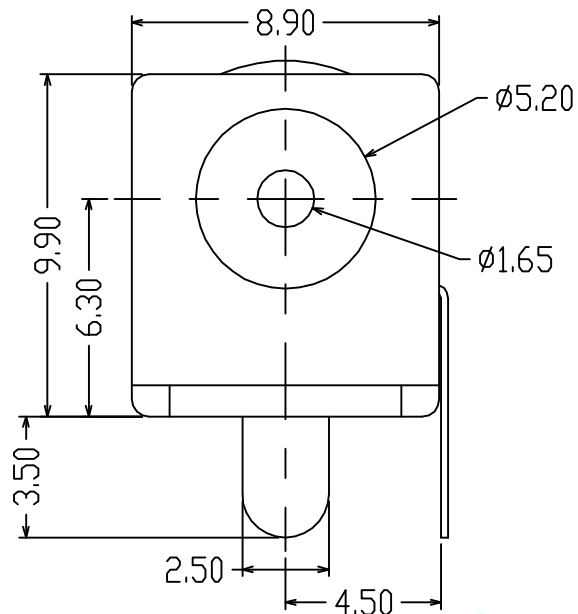
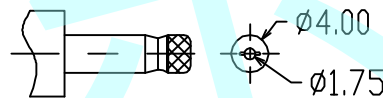

DC MATE PLUG

NOTES:

1. Rating: 0.5A 30V DC
2. Contact Resistance: 100mΩ Max
3. Operating temperature: -20°C ~ 70°C
4. Operating force: 3-20N
5. Operating Life: 5,000 cycles

DC-072-A

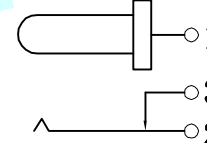

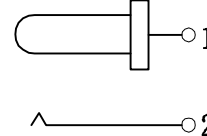

CIRCUIT DIAGRAM

DC-072-B



CIRCUIT DIAGRAM

APPROVALS		DATE	http://www.dongdudz.com		 <b>东都电子</b> DONGDU ELECTRONICS	
DRAW:	ZRD	2017-12-6	TOLERANCE:	ANGLE:		
CHECKED:	***	***	30≥	±0.30		±2°
APPOVALS:	***	***	10~30	±0.20		
			5~10	±0.15		
			≤5	±0.10	MODEL: DC POWER JACK PART NO: DC-072 UNIT :mm SCALE:1:1  REV: A PAGE:1/1	