

ROHS

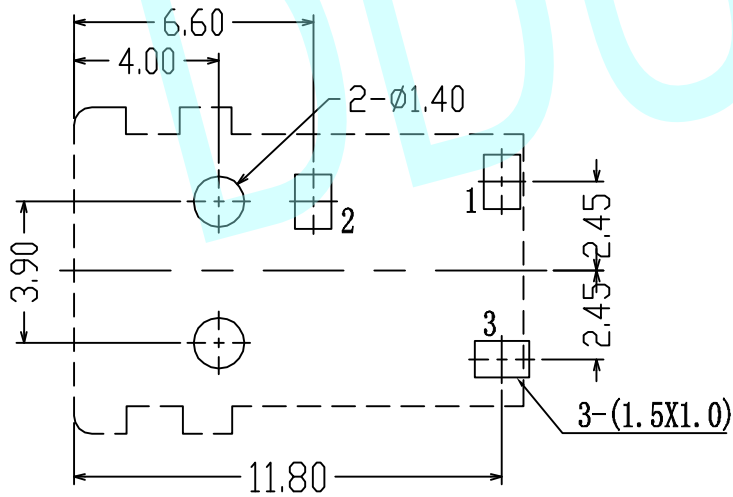

PCB Layout (Copper-Side View)

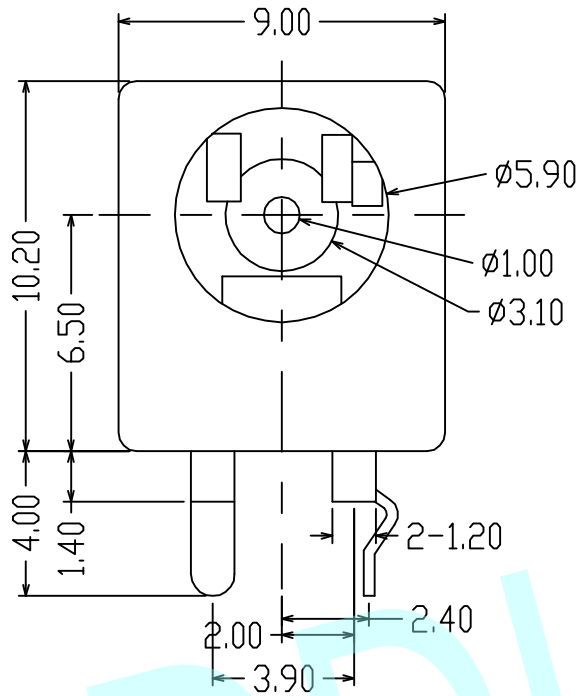
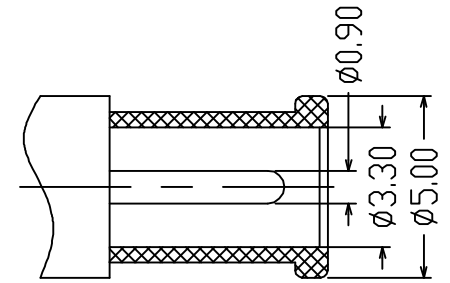
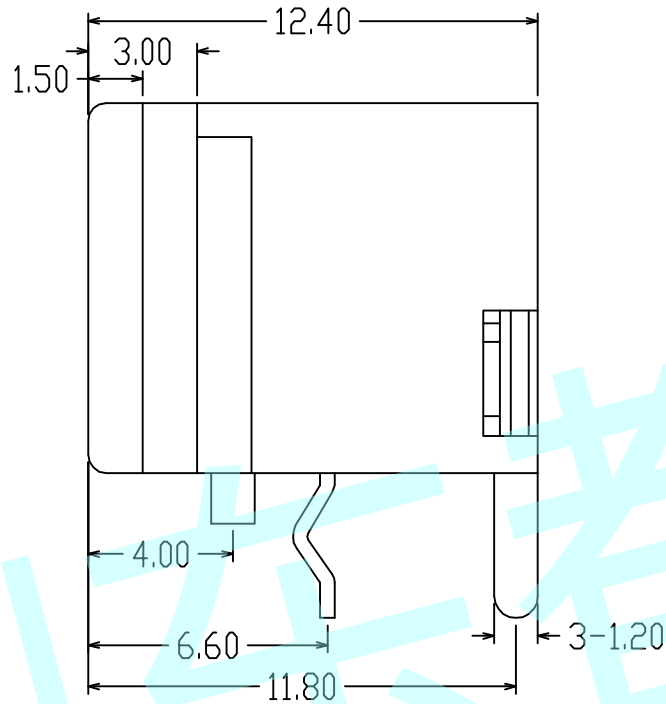

DC MATE PLUG

DC-029-A

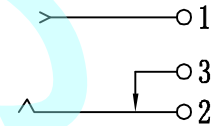

CIRCUIT DIAGRAM

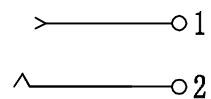

DC-029-B



CIRCUIT DIAGRAM

NOTES:

1. Rating:0.5A 30V DC
2. Contact Resistance:100mΩ Max
3. Operating temperature:-20℃~70℃
4. Operating force:3-20N
5. Operating Life:5000 cycles

APPROVALS		DATE	http://www.dongdudz.com	
DRAW:	ZRD	2017-12-6	TOLERANCE:	ANGLE:
CHECKED:	***	***	30≥ ±0.30	±2°
APPOVALS:	***	***	10~30 ±0.20	
			5~10 ±0.15	
			≤5 ±0.10	
			 ® 东都电子 DONGDU ELECTRONICS	
MODBL:		DC POWER JACK		
PART NO:		DC-029		
UNIT :mm	SCALE:1:1			
REV:	A	PAGE:1/1		