

ROHS

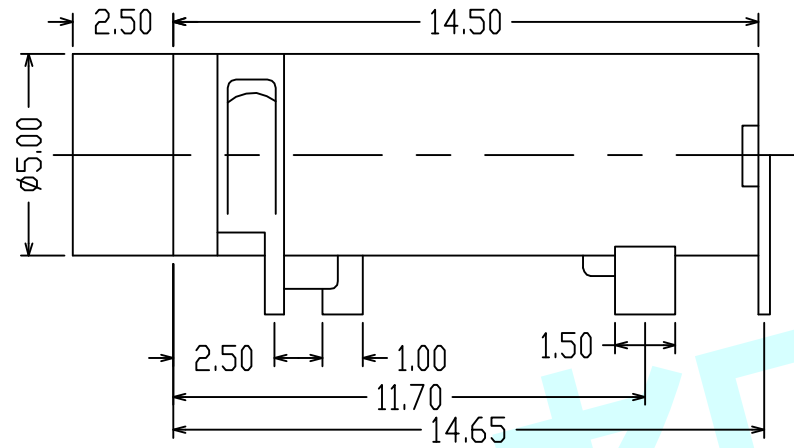

PCB Layout (Copper-Sided View)

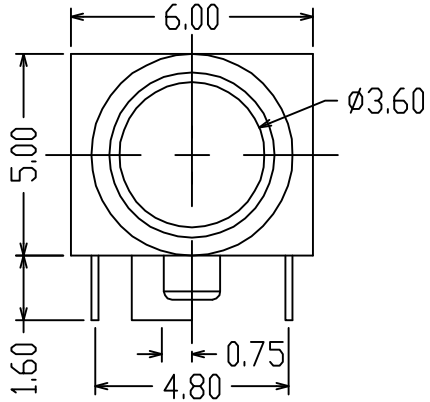
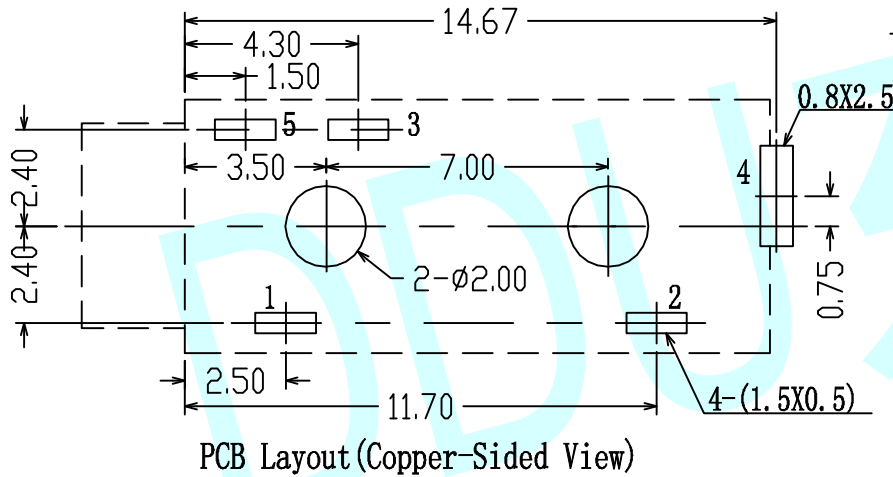

PCB Layout (Copper-Sided View)

NOTE:

1. Rating: 0.5A 30V DC
2. Contact Resistance: 100mΩ Max
3. Operating Temperature: -20°C ~ 70°C
4. Operating Force: 3-20N
5. Operating Life: 5,000 Cycles

Schematic

PJ-267-A

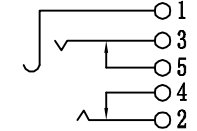

PJ-267-B

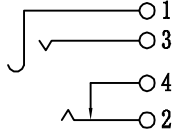

PJ-267-C

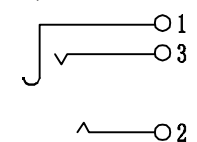

PJ-267-D

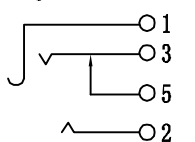

APPROVALS		DATE	http://www.dongdudz.com	
DRAW:	ZRD	2017-12-6	TOLERANCE:	ANGLE:
CHECKED:	***	****	30° ≥ ±0.30	±2°
APPOVALS:	***	****	10°~30 ±0.20	
			5°~10 ±0.15	
			≤5 ±0.10	
				<b>东都电子</b> DONGDU ELECTRONICS
				MODEL: PHONE JACKES PART NO: PJ-267 UNIT :mm SCALE: 1:1
				REV: A PAGE: 1/1