

ROHS

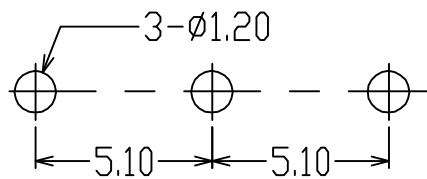

PCB Layout

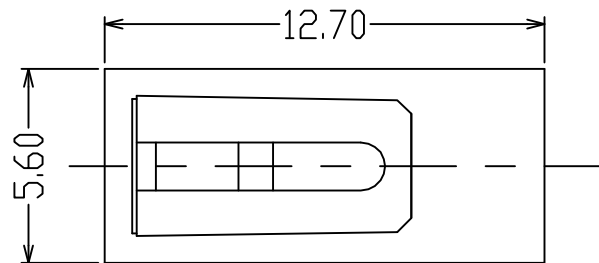

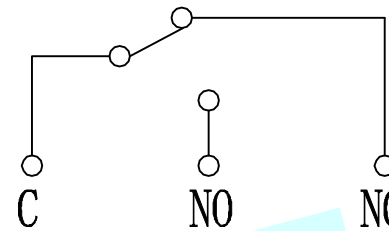

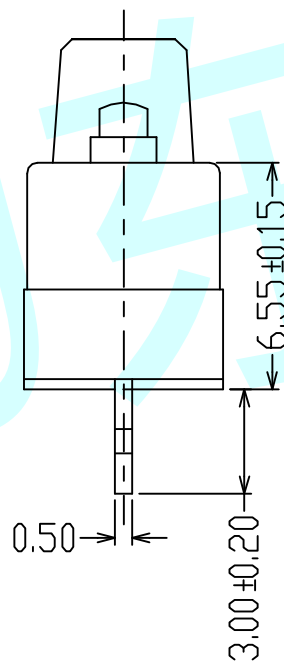
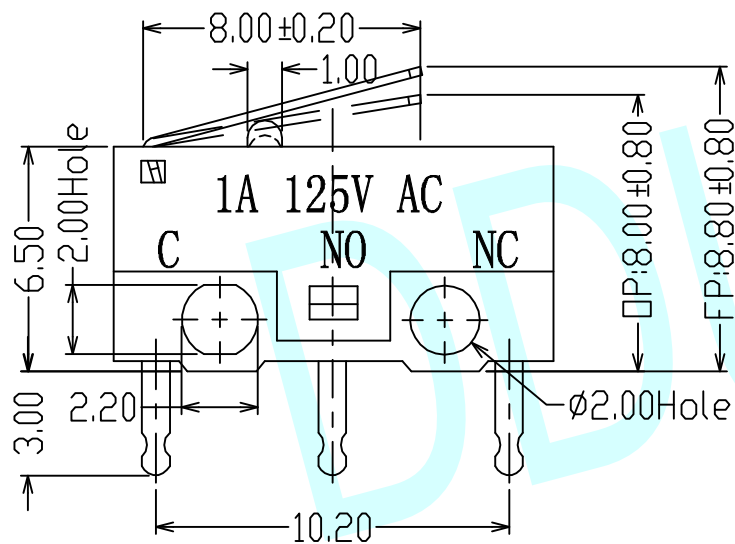
Circuit Diagram



NOTES:

1. Rating :AC 125V 1A
2. Operating Froce :30±15gf
- 3.3. Mechanical Life :100,000 cycles

APPROVALS		DATE	http://www.dongdudz.com		 东都电子 DONGDU ELECTRONICS
DRAW:	ZRD	2017-12-6	TOLERANCE:	ANGLE:	
CHECKED:	***	****	30° ≥ ±0.30	±2°	
APPOVALS:	***	****	10°~30 ±0.20		
			5°~10 ±0.15		
			≤5 ±0.10		MODEL: MICRO SWITCHES PART NO: DDU-1716 UNIT :mm SCALE:1:1  REV: A PAGE:1/1