

**ROHS**

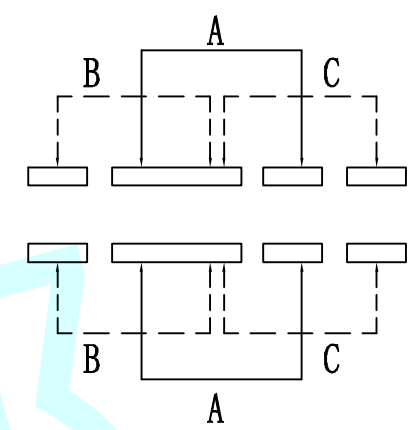

PCB Layout (Pattern Side)

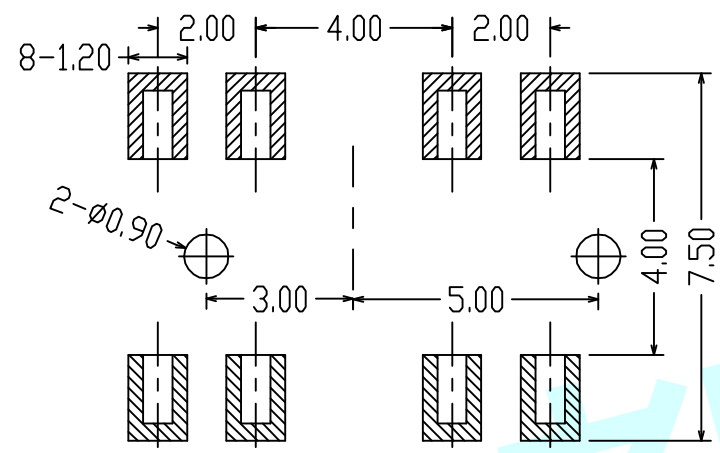
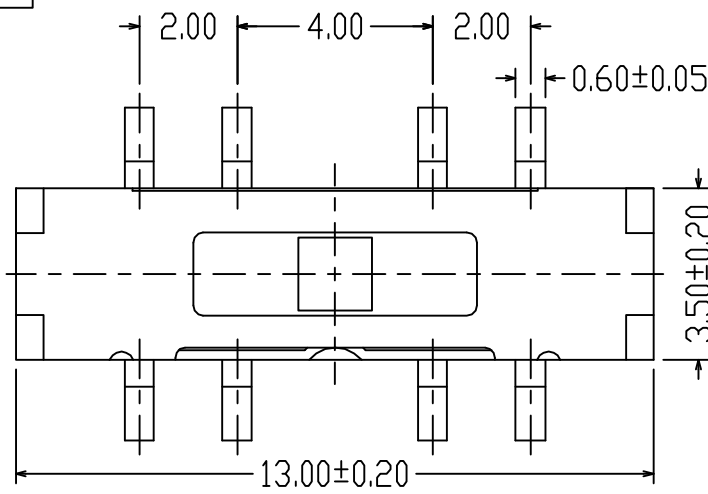
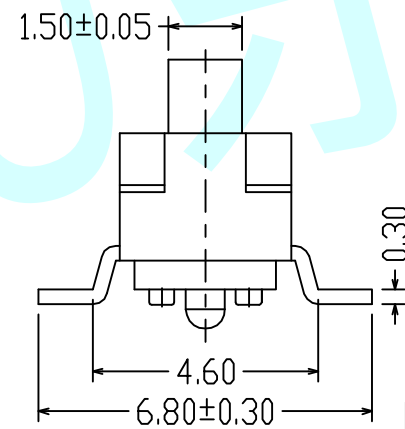
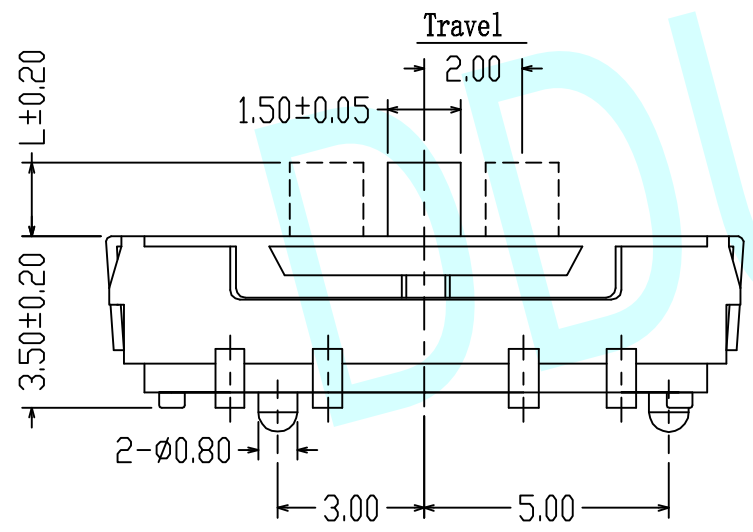

Circuit Diagram



**NOTES:**

1. Rating: DC 6V 300mA
2. Contact Resistance:  $\leq 50m\Omega$
3. Insulation Resistance:  $\geq 100M\Omega$
4. Withstand voltage: AC 500V 1 Minute
5. Electrical Life: 10,000 Cycles above (Load)
6. Mechanical Life: 10,000 Cycles (NO Load)
7. Operating force range:  $250gf \pm 100gf$
8. Operating temperature range:  $-25^{\circ}C + 80^{\circ}C$
9. Ambient humidity used:  $\leq 85\%RH$
10. Solder ability:  $245^{\circ}C \pm 50^{\circ}C$ ,  $3S \pm 0.5S$
11. Withstand Soldering temperature:  $260^{\circ}C \pm 5^{\circ}C$ ,  $3S \pm 1S$

L	2.00	3.00	4.00
---	------	------	------

APPROVALS		DATE	http://www.dongdudz.com		 <b>东都电子</b> DONGDU ELECTRONICS
DRAW:	ZRD	2017-12-6	TOLERANCE:	ANGLE:	
CHECKED:	***	***	30°	±2°	
APPOVALS:	***	***	10°30		
			5°10		
			≤5	±0.10	
MODEL:	TOGGLE SWITCHES		PART NO:	DDU-1411S	
UNIT :mm	SCALE: 1:1				
REV:	A			PAGE: 1/1	