

ROHS

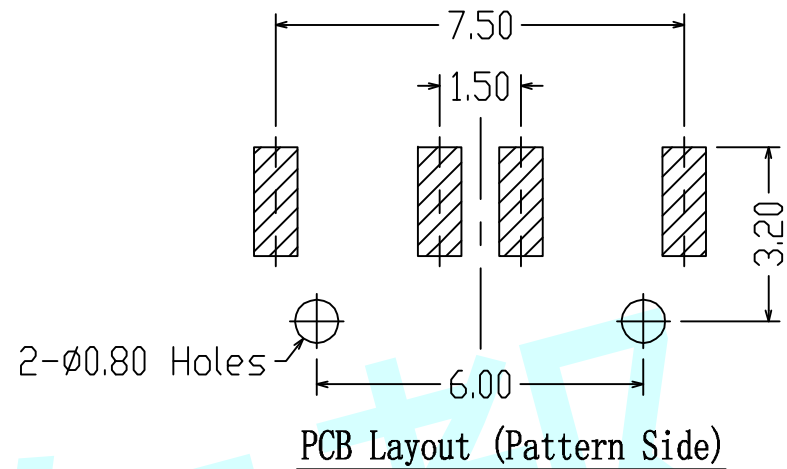

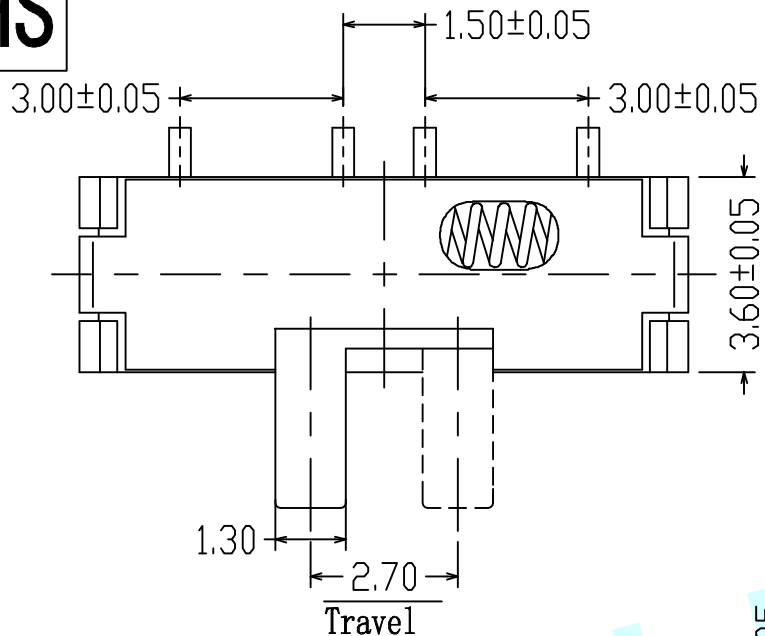

PCB Layout (Pattern Side)

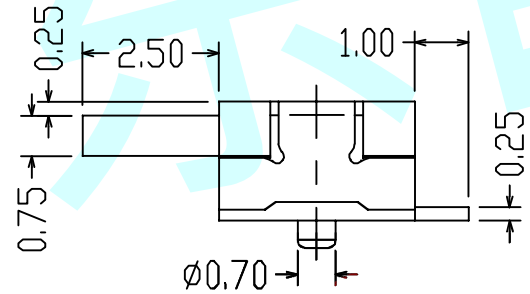
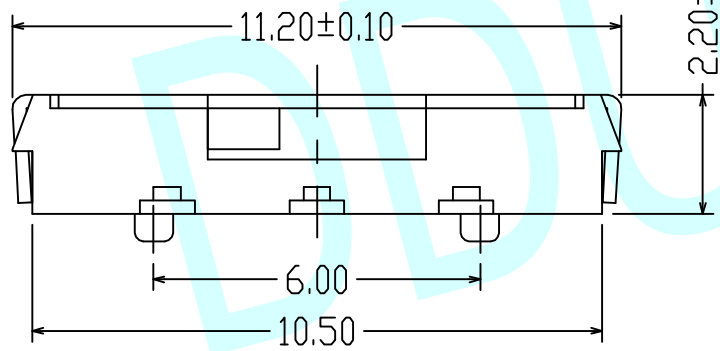

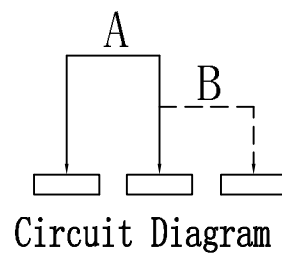
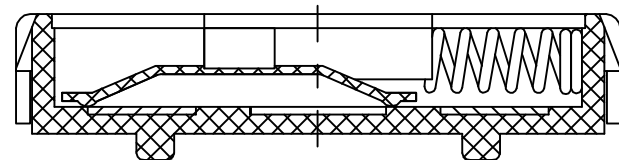
NOTE:
1. Operating Force: 200 ± 100 gf



Circuit Diagram

APPROVALS		DATE	http://www.dongdudz.com		 ® 东都电子 DONGDU ELECTRONICS	
DRAW:	ZRD	2017-12-6	TOLERANCE:	ANGLE:		
CHECKED:	***	***	30°	±0.30		±2°
APPOVALS:	***	***	10°30'	±0.20		
			5°10'	±0.15		
			≤5	±0.10	MODEL: TOGGLE SWITCHES PART NO: DDU-1426 UNIT :mm SCALE:1:1  REV: A PAGE:1/1	