

**ROHS**

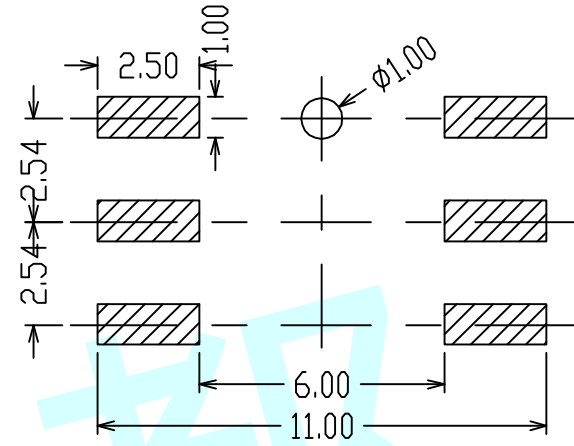

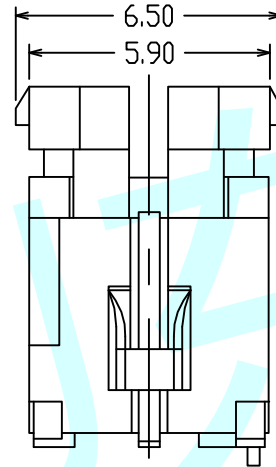

PCB Layout (Pattern Side)

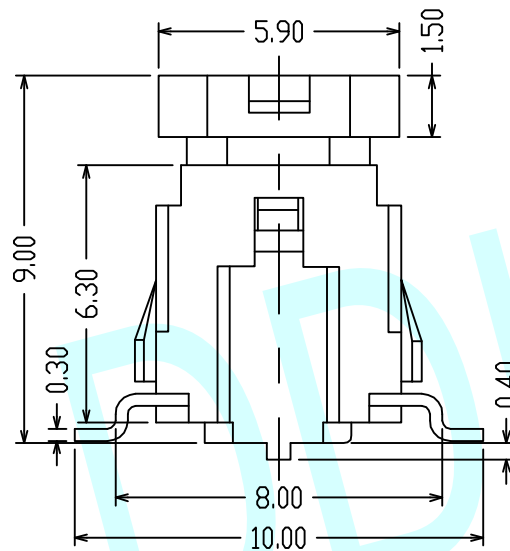
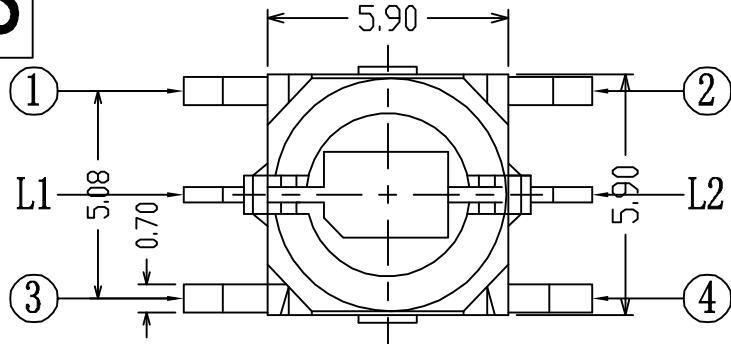
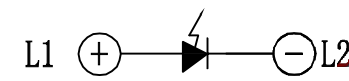
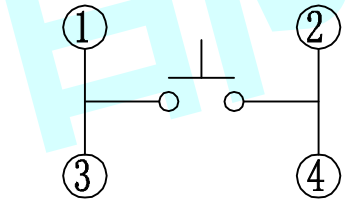

Circuit Diagram

**NOTES:**

1. Rating:12V DC 50mA
2. Contact Resistance:100mΩ Max
3. Insulation Resistance:100MΩ 250V DC FOR 1MIN
4. Dielectric Strength:250V AC(50/60Hz) FOR 1MIN
5. Life Test:100,000 Cycles
6. Operation Force:160±50gf/250±50gf
7. Travel:0.25±0.10mm
8. Operating temperature range:-20℃~+70℃

LED Colour (LED颜色)		Whiler (白色)	Red (红色)	Blue (蓝色)	Green (绿色)
APPROVALS		DATE	http://www.dongdudz.com		
DRAW:	ZRD	2017-12-6	TOLERANCE:	ANGLE:	
CHECKED:	***	****	30≥	±0.30	±2°
APPOVALS:	***	****	10°30	±0.20	
			5°10	±0.15	
			≤5	±0.10	
 <b>东都电子</b> DONGDU ELECTRONICS		MODBL: LED Tact Switch PART NO: DDU-1508 UNIT :mm SCALE:1:1  REV: A PAGE:1/1			