

ROHS

OK

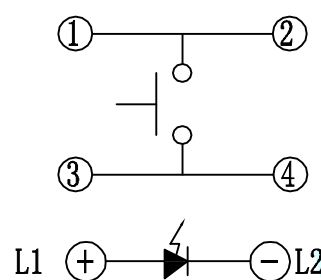

Circuit Diagram

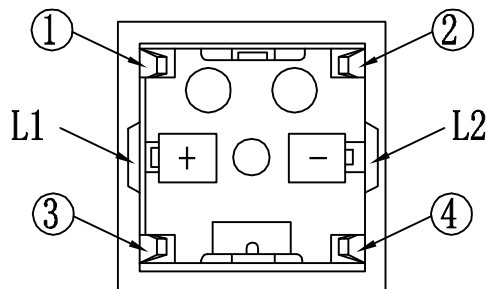
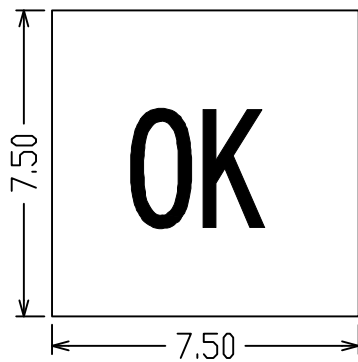
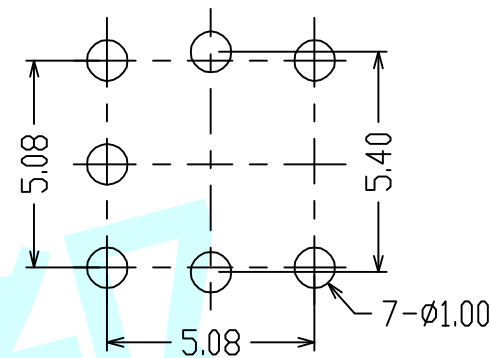

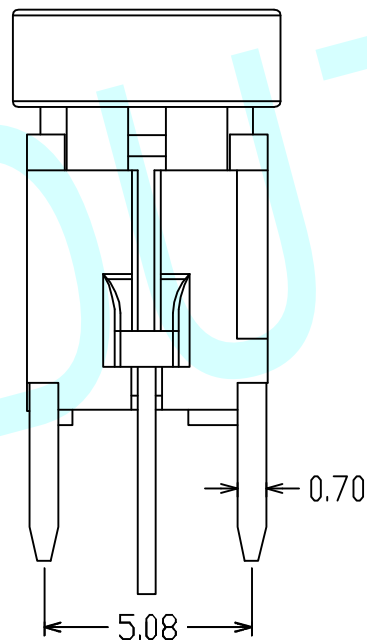
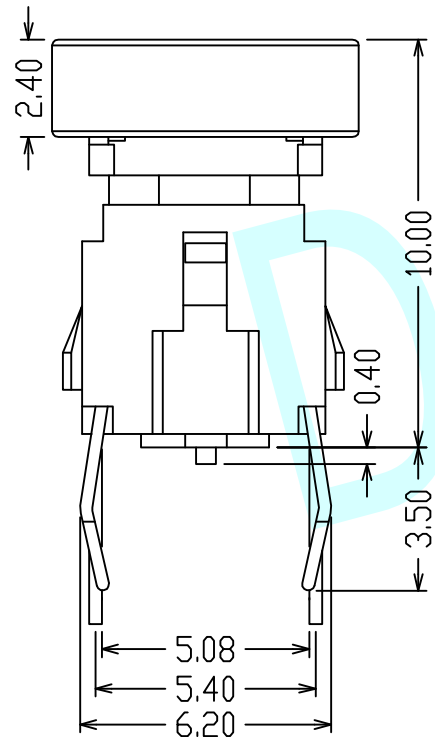

PCB Layout (Pattern Side)



NOTES:

1. Rating: 12V DC 50mA
2. Contact Resistance: 100mΩ Max
3. Insulation Resistance: 100MΩ 250V DC FOR 1MIN
4. Dielectric Strength: 250V AC (50/60Hz) FOR 1MIN
5. Life Test: 100,000 Cycles
6. Operation Force: 160±50gf/250±50gf
7. Travel: 0.25±0.10mm
8. Operating temperature range: -20°C~+70°C

LED Colour (LED颜色)		Whiler (白色)	Red (红色)	Blue (蓝色)	Green (绿色)
APPROVALS		DATE	http://www.dongdudz.com		
DRAW:	ZRD	2017-12-6	TOLERANCE:	ANGLE:	
CHECKED:	***	****	30≥	±0.30	±2°
APPROVALS:	***	****	10~30	±0.20	
			5~10	±0.15	
			≤5	±0.10	
MODBL:		LED Tact Switch		 东都电子 DONGDU ELECTRONICS	
PART NO:		DDU-1513			
UNIT :mm		SCALE: 1:1			
REV:		A		PAGE: 1/1	